

**EM&CP BLK Monday, February 14, 2022**

Intro to Objects

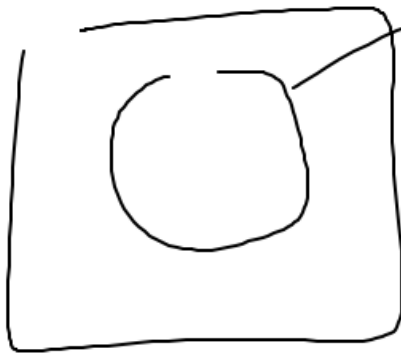

circle - object  
instances of the  
Circle Class

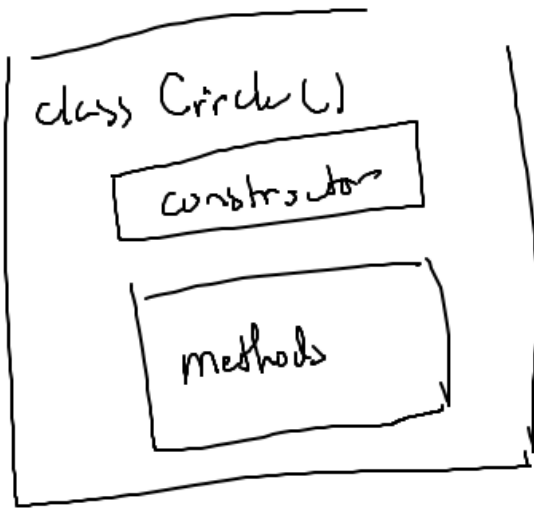

Obj. Circle (

↳ calling constructor for the  
Circle class

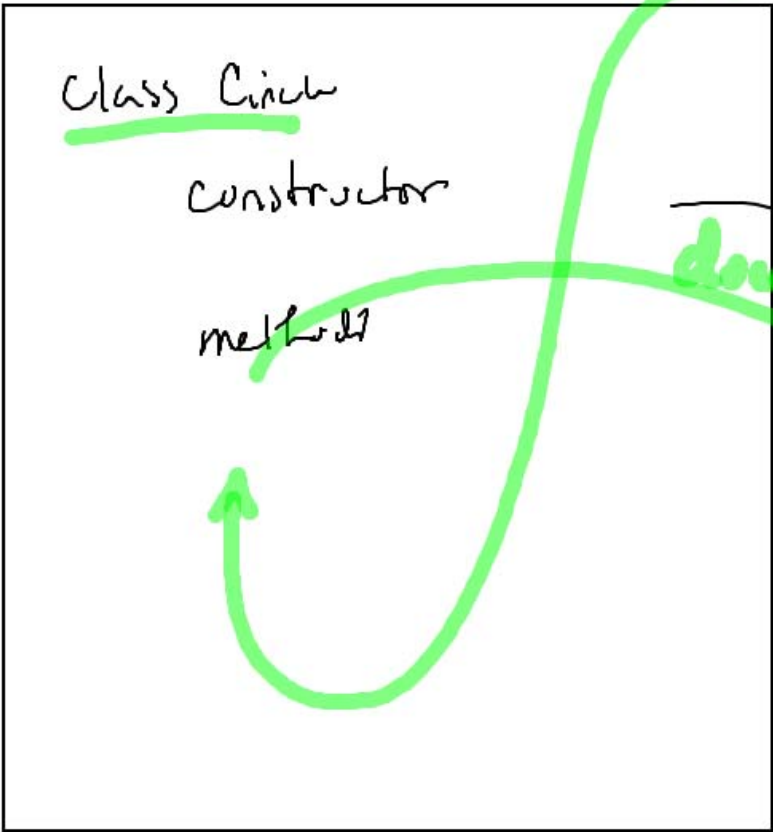

looks up

object/instance  
↓

does

myCir

myCir.getCenter()



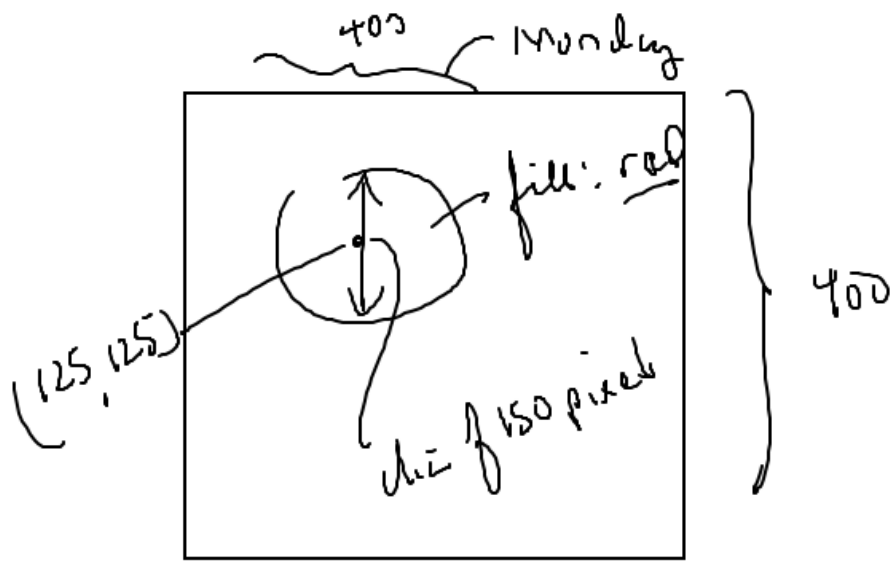

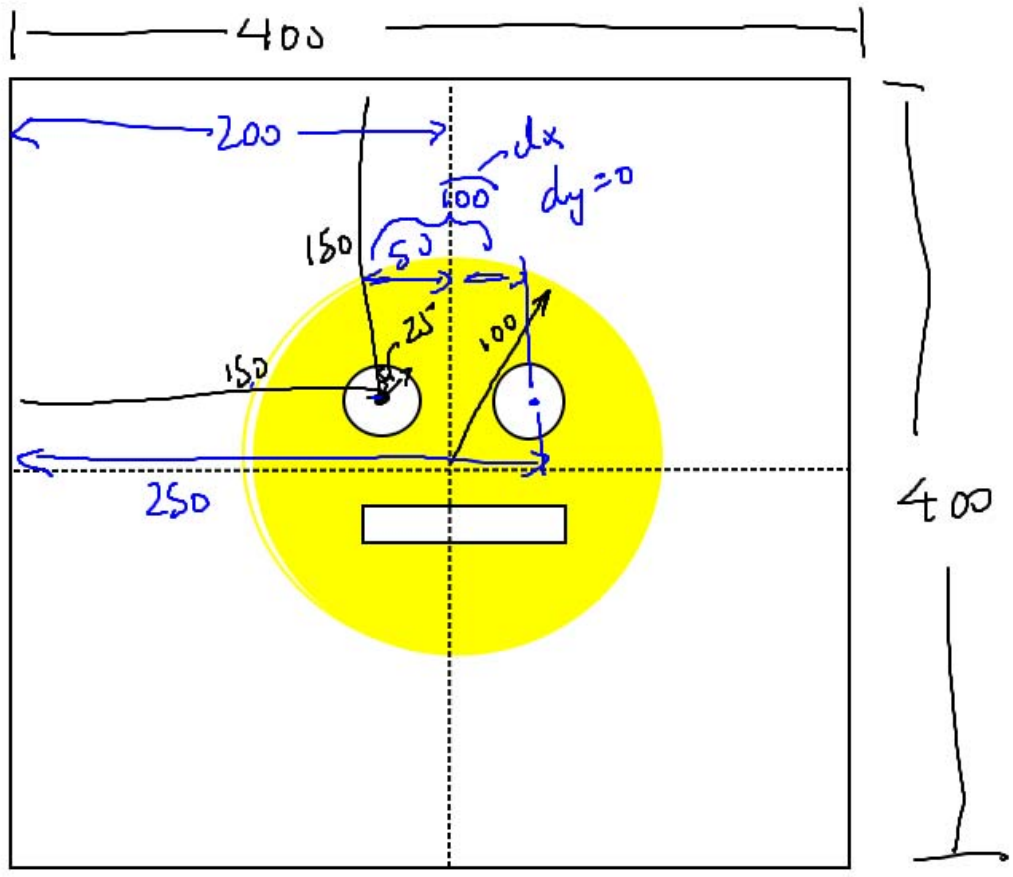

$$y = x$$

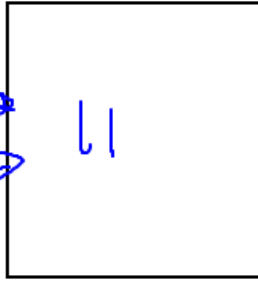

y



$$\textcircled{\times} \ominus \textcircled{\times} + 1 = 12$$

↑  
11



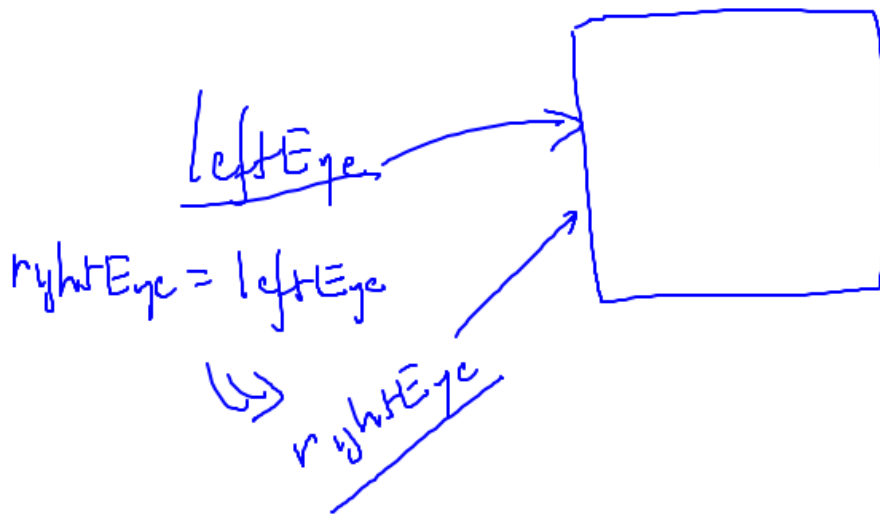

Import  
w/s

def main():



✓main()

